



LCEC and EC Accessories

January 2001

A-1302 ELECTRODE POLISHING AND CARE

Cross-Flow Cell Package
UniJet Cell Package
C3 Voltammetry Cell Stand
Rotating Disk Electrode
Low Current Module
Calomel Reference Electrode

Bioanalytical
Systems, Inc
2701 Kent Avenue
West Lafayette
Indiana 47906

www.bioanalytical.com

Thank you for your recent purchase from BAS. This manual includes instructions for several different products, and should be used as a supplement to various BAS instrument manuals. Due to continuing development of our line, some products may be slightly different in appearance from the drawings depicted here. These changes should not affect performance or the relevant use and maintenance instructions. Check the inserts that may be provided with individual electrodes for additional notes or revisions.

Working electrodes are warranted for 60 days from date of shipment. Reference electrodes are considered consumable items and are not covered by a timed warranty period. We warrant only that they are viable as shipped. Their lifetime after purchase will depend solely on usage and storage conditions.

Copyright May 1998, January 2001

Bioanalytical Systems, Inc.
2701 Kent Avenue
West Lafayette, IN 47906 USA

www.bioanalytical.com

ALL RIGHTS RESERVED

UniJet, UniStand, and SepStik are trademarks of Bioanalytical Systems, Inc.

Vycor is a registered trademark of Corning Glass.

Kel-F is a registered trademark of 3M Corporation.

Table of Contents

Section 1. Thin-Layer Cells.....	1
1.1 Working Electrode.....	1
1.2 Reference Electrode.....	1
1.3 Auxiliary Electrode.....	2
1.4 Design of the Cross-Flow Cell.....	2
1.5 Design of the Radial-Flow Cell.....	4
Section 2. Voltammetry Cells.....	5
2.1 Working Electrode.....	5
2.2 Reference Electrode.....	6
2.3 Auxiliary Electrode.....	6
Section 3. Polishing Guidelines.....	7
3.1 General Guidelines for Polishing Electrodes.....	9
3.2 Polishing Glassy Carbon, Silver, or Nickel.....	10
3.3 Electrochemical Cleaning of Platinum.....	12
3.4 Polishing Platinum and Pure Gold.....	12
3.5 Polishing Amalgamated Gold.....	14
3.5.1 Polishing Gold Electrodes in PEEK.....	15
3.6 Preparing Carbon Paste Electrodes.....	18
3.7 Microelectrode Polishing.....	20
3.8 Polishing the UniJet Electrode.....	20
Section 4. Reference Electrodes.....	21
4.1 Assembling the RE-2 Calomel Reference Electrode.....	21
4.2 Silver/Silver Chloride (Ag/AgCl) Reference Electrodes.....	24
4.3 UniJet Reference Electrodes.....	28
4.4 Silver/Silver Ion (Nonaqueous) Reference Electrodes.....	29
4.5 Replacing the Vycor Tip.....	30
Section 5. Part Numbers.....	31
5.1 Polishing Kit and Supplies.....	31
5.2 Thin-Layer Cell Parts For Current Model LC-44 Detector.....	32
5.3 Thin-Layer Cell Parts for Older Cell Designs.....	33
5.4 Voltammetry Electrodes.....	34
Index.....	35

Section 1. Thin-Layer Cells

A complete thin-layer transducer cell for LCEC includes three separate electrodes: a working electrode, a reference electrode, and an auxiliary electrode.

1.1 Working Electrode

The working electrode consists of a carbon or metal rod embedded in a plastic block. Glassy carbon is the most common electrode for LCEC. Specialty materials such as platinum, gold, silver, nickel, and carbon paste are used for specific assays described in BAS applications capsules.

The block is made of PEEK (polyetheretherketone) and is resistant to solvents and temperatures normally used in liquid chromatography/electrochemistry. PEEK will be chemically degraded by concentrated nitric and/or sulfuric acids, but diluted HNO_3 may be used to remove mercury from gold amalgam electrodes without harming the PEEK surface. Working electrodes are maintained by polishing as needed, using the instructions given in this manual (Section 3). Instructions differ according to working electrode material. We do not recommend polishing methods or materials other than those described in this manual.

1.2 Reference Electrode

BAS offers several different designs of reference electrodes which fit into either previous or current cell models. Drawings of each electrode type used in BAS Electrochemical Detectors are shown in Figure 1.1. If you are reordering an electrode and are still in doubt, please call (1-800-845-4246).

Figure 1.1. BAS electrochemical detectors and voltammetry instruments have used several different reference electrodes during the past decade. If you need a replacement and are unsure about the correct model, consult the current BAS catalog.

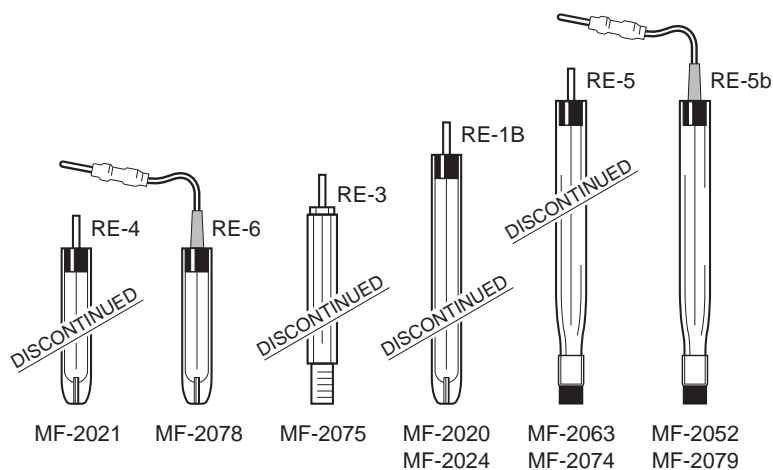

BAS uses silver/silver chloride reference electrodes that vary according to the ion junction at the tip and the overall size. The position of the reference electrode in relation to the other electrodes will differ according to the model of cell used.

1.3 Auxiliary Electrode

Both past and current cells use a stainless steel auxiliary electrode. In current model cells, the reference electrode is housed within the auxiliary electrode block. A gasket is sandwiched between the auxiliary and the working electrode blocks, forming the thin-layer channel in which the electrochemical reaction takes place (Figure 1.2).

1.4 Design of the Cross-Flow Cell

The cross-flow cell design offers a number of advantages. Thermal stability has been achieved through the use of an optional cell preheater. The preheater will eliminate thermal drift of the mobile phase associated with changes in room temperature. This becomes important when the detector is used with an autosampler for overnight runs where room heating or cooling is curtailed after hours. This design also offers low dead volume, allowing fraction collection or coupling to other detectors with minimal band spreading.

The complete cell, as shown in Figure 1.2, is available only within the LC-44 ordering system or as part of a BAS Chromatographic Analyzer. Spare working and reference electrodes may be purchased separately.

Figure 1.2. Cross-flow thin-layer amperometric cell design.

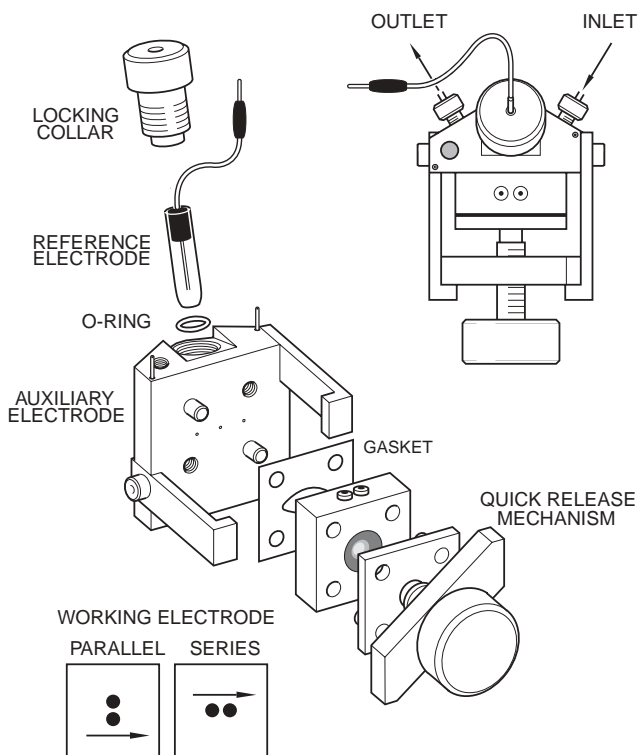

BAS cross-flow electrodes for LCEC have two separate electrodes embedded in a PEEK block. The two electrodes can be the same or made of two different materials. The working electrodes can be operated independently (by two separate amperometric controllers or one LC-4C), together (joined by a special coupler [MW-2010] to effectively double the electrode surface area), or alone (with one electrode remaining unused and ready as a backup) (Figure 1.3).

Figure 1.3. Alternative configurations for a dual, cross-flow working electrode.

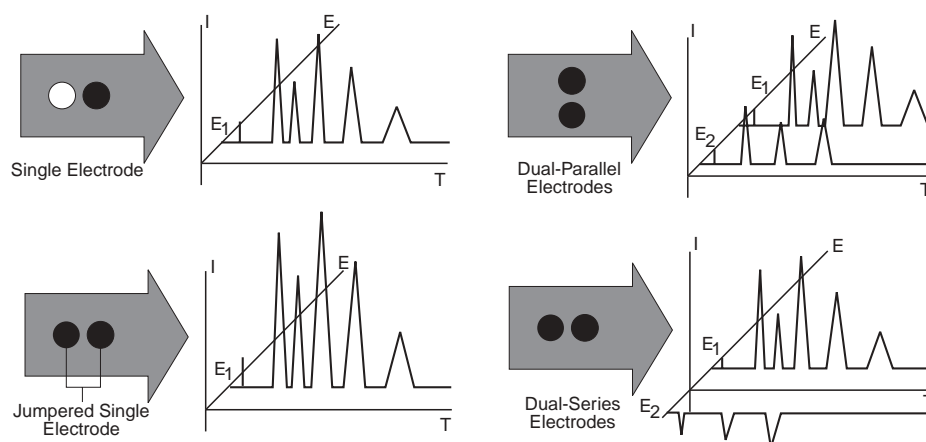

1.5 Design of the Radial-Flow Cell

The UniJet™ detector (Figure 1.4) is a new addition to the BAS line of amperometric detectors for liquid chromatography. The detector has been designed with microbore chromatography in mind. Due to the stringent requirements of minimal dead volume in microbore systems, the UniJet detector was designed as the end fitting of the UniJet™ microbore column. In order to keep the overall size and the internal volume to a minimum, a radial flow pattern was used (Figure 1.5) (this is not wall-jet hydrodynamics). In comparison to the more traditional approach of a cross-flow cell, the radial-flow cell gives improved response at microbore flow rates ($\leq 200 \mu\text{L}/\text{min}$) and less dilution of the sample before the detector. The radial flow profile also allows for more rapid equilibration of the electrode. The UniJet detector cell allows for a variety of reference electrodes to be used without a liquid junction (salt bridge).

Figure 1.4. UniJet assembly.

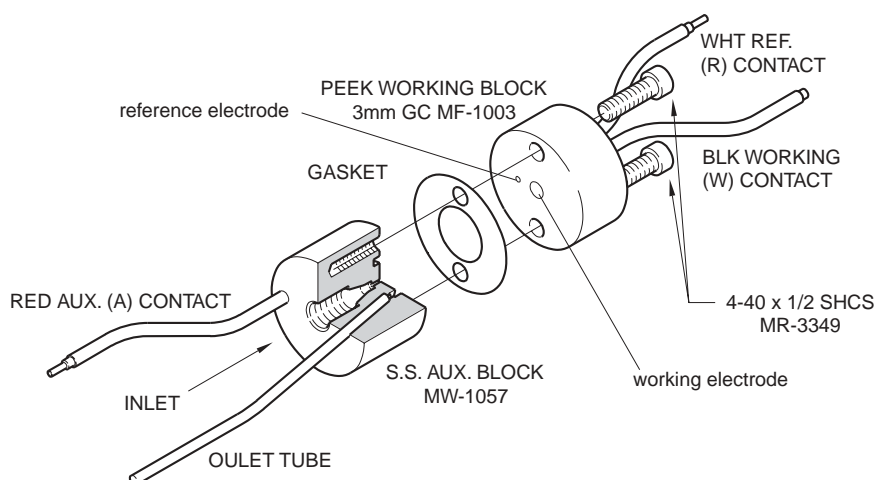
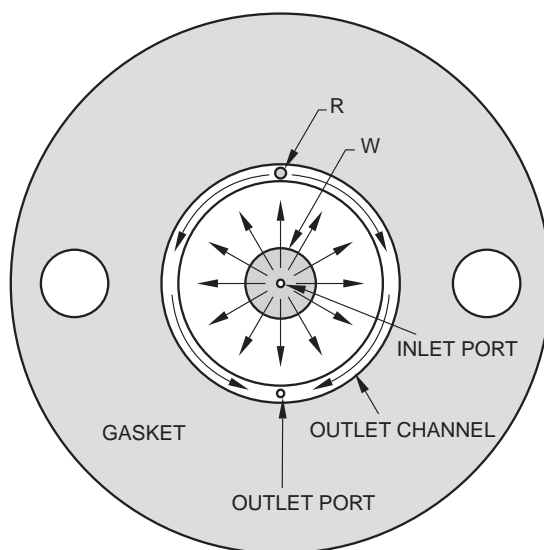

Figure 1.5. Flow pattern for radial-flow cell.



Section 2. Voltammetry Cells

A complete voltammetry cell includes three separate electrodes: a working electrode, a reference electrode, and an auxiliary electrode.

2.1 Working Electrode

Current model BAS voltammetry electrodes are embedded in glass or a CTFE[®] rod. The electrode will easily withstand exposure to the solvents and temperatures commonly used in electroanalytical studies, although prolonged exposure to tetrahydrofuran and halogenated solvents is not recommended.

The working electrode can be made from one of several different materials. Glassy carbon and platinum are most commonly used. Specialty materials such as gold, silver, nickel, and carbon paste are used for specific assays. These assays are described in BAS applications notes or the published literature. A small O-ring can be used to adjust the electrode height in the cell. Figure 2.1 shows the following three working electrodes:

Voltammetry Electrodes are encased in CTFE plastic rod.

Voltammetric Microelectrodes are thin platinum, gold, or carbon wires embedded in glass. They may be used in the same voltammetry cell as the CTFE working electrodes.

Rotating Disk Electrode tips are embedded in a CTFE rod. The tips are threaded for easy replacement on the RDE-1 shaft.

Figure 2.1. Working electrodes for voltammetry cells.

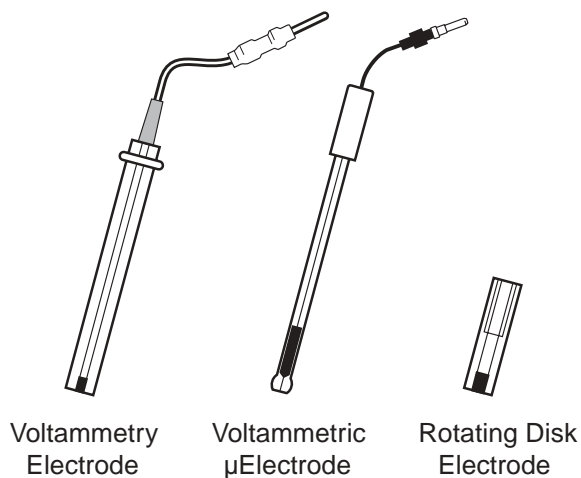

A special microcell for use with microliter (50 to 200 μL) volumes of sample is also available. This uses a carbon paste working electrode, or voltammetric microelectrode.

Working electrodes are maintained by polishing as needed, using the instructions given in this manual (see Section 3). Note that the instructions differ according to the working electrode material. There are some additional precautions when working with microelectrodes.

2.2 Reference Electrode

One Ag/AgCl reference electrode with a 3 M NaCl aqueous filling solution is provided with C3 voltammetry cells and rotating disk electrodes. The MF-2052 reference electrode will fit into the normal voltammetry cell. If you prefer to use a nonaqueous reference electrode, MF-2062 can be substituted. A calomel electrode (RE-2) is also available in kit form. Figure 2.2 shows reference electrodes for voltammetry cells.

Figure 2.2. Reference electrodes for voltammetry cells.

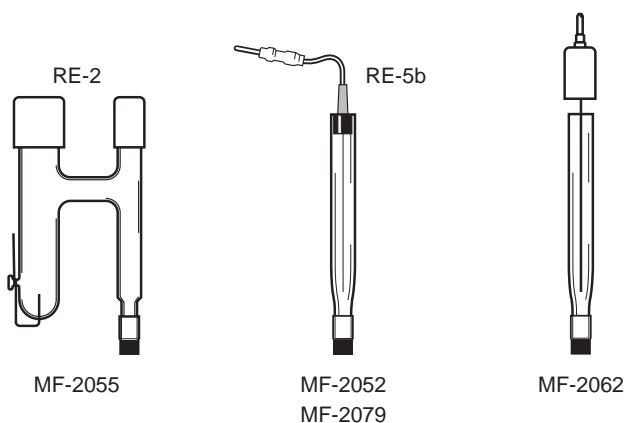

2.3 Auxiliary Electrode

The auxiliary electrode takes the form of a platinum wire mounted in a CTFE cylinder. The platinum wire with soldered gold connector can be purchased separately, or as part of a replacement block. In the RDE-1 rotating disk electrode, a separate auxiliary electrode is used; this takes the form of a coiled platinum wire with much higher surface area. Figure 2.3 shows auxiliary electrodes for voltammetry cells.

Figure 2.3. Auxiliary electrodes for voltammetry cells.

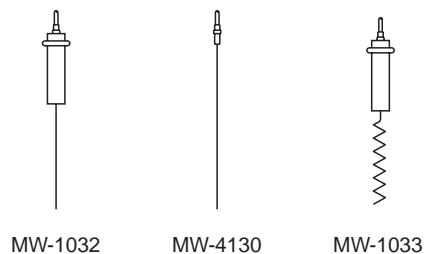

Section 3. Polishing Guidelines

The objective of polishing the electrode is to remove the redox reaction products that accumulate during some experiments. The rate of electrode coating (and corresponding decrease in responsiveness) depends on:

1. The analyte molecule
2. The concentration of the analyte molecule
3. The composition of the electrolyte solution (including pH)
4. The applied potential
5. The frequency of use

Electrodes used in liquid chromatography may last for several months without repolishing in some applications. LCEC has the advantage of using a flowing stream which helps to remove redox products, and deals with much lower concentrations of analytes than does voltammetry. Electrodes also can accumulate material by adsorption from the atmosphere. For example, components in cigarette smoke and aerosols of various compositions can affect electrode performance. Silver is easily oxidized under such conditions and should be carefully repolished to remove oxides prior to use.

There are many rumors and horror stories about electrode polishing. There are also some home-made polishing recipes that we specifically discourage. The use of concentrated acid is one. Use of jeweler's rouge, toothpaste, Aunt Ruth's fruitcake (vintage 1972) and other abrasive compounds should be fervently avoided. Many of these home remedies do not work and may harm the electrode. One thing is certain: The need for polishing varies dramatically with the application.

There are many potential causes for that "glitch" or noise in the baseline. Don't routinely conclude that polishing the electrode will cure all. As a rule, polishing is justified when you see a gradual decrease in the response of the electrode (Figure 3.1). You can live with decreased response if you are still able to quantitate the peaks of interest and if you periodically inject a set of standards. In many cases, a light buffing of the working electrode surface with a methanol-soaked lab tissue is all that's needed to restore the electrode. Try this first! If such a treatment improves the response only slightly, then the use of polishing abrasives is the next logical step.

Figure 3.1. Example of gradual decrease in the responsiveness of an electrode, indicating the need for polishing.

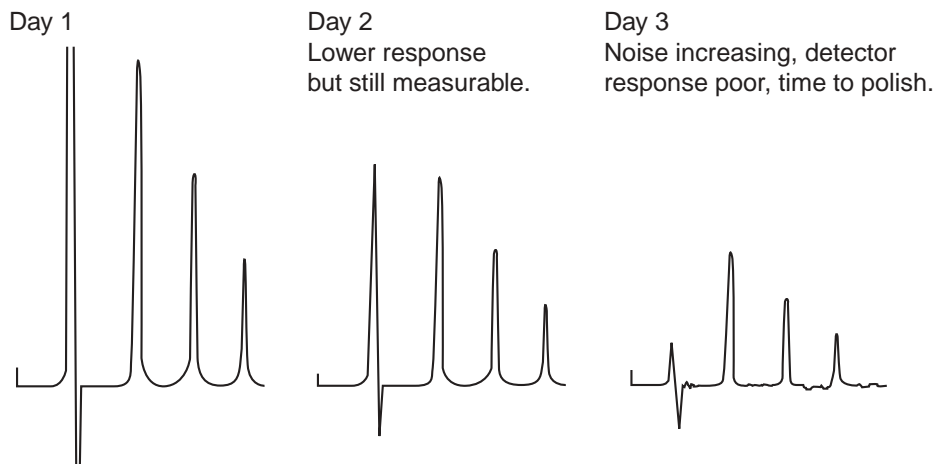

A series of one to three abrasives is used for polishing, progressing from coarser materials to very fine polishes used on soft-surfaced pads. The polishing process should remove a negligible amount of electrode material. In most cases, a single abrasive is used to lightly erode the surface and physically remove the contaminants. Precious metal electrodes or chemically modified electrodes (e.g., gold/mercury amalgam) tend to require a series of two or three abrasives to restore the original mirror-like finish.

All polishing steps require *extensive rinsing* and flushing of the electrode before moving on to the next stage. Without this washing, minute particles from the previous polishing step will be carried over and will hinder the progression towards smaller-sized particles of abrasive. Plastic squeeze bottles with thin nozzles are best for rinsing. Fill one with clean, distilled water for rinsing alumina polish. Fill another with methanol for rinsing diamond polishes. Label the bottles.

A major concern of polishing is that you do not erode the softer electrode below the surface of the surrounding plastic or glass. This can be avoided by polishing the electrode on a hard flat surface. Follow the general guidelines in Section 3.1 when handling your working electrode.

3.1 General Guidelines for Polishing Electrodes

1. It is important to use the polishing materials provided by BAS and to follow the recommended procedure. The polishing kit provided with your BAS instrument gives you all materials needed for all polishing procedures. Individual polishes, pads, or the entire kit can be purchased separately.
2. Before use, shake all bottles of polishing slurry well to ensure that all the grit is evenly suspended.
3. Only one grade of polishing slurry is to be applied to the pad; that is, use a different pad for each polishing step. Do not add fresh polishing compound to pads once a particular polishing step has been initiated; add sufficient slurry at the beginning. If additional lubrication is required, add water to the pad.
4. While most individual nylon (white) polishing pads may be reused, the fine grit polishing pad (black to dark gray in color) should be used one time only. If used more than once, excess scratching may occur due to the spaces between the grit being filled in with PEEK, causing a deeper pressure scratch to occur.
5. The diamond slurries (15- μm blue, 6- μm orange, 3- μm yellow, and 1- μm gray) have an oil base, so a methanol or acetone flush of the electrode is required.
6. The pads have self-adhesive backs and are less likely to rise off the glass when wetted if applied to the glass plate the previous day. Clean the glass plate with methanol first. Then peel the pad and push down from the center out to the edge so no air pockets are trapped between pad and plate (so no high spots are produced). Label each plate for the appropriate grade of slurry to be used.
7. Moisten the pads with distilled water a few minutes prior to use. This will aid in breaking up any clumps of grit that were not rinsed off from a previous use. The excess polishing grit should always be rinsed off the pads after use to lessen the chances of clumping. Large clumps of grit will excessively scratch the gold and PEEK.
8. Rinse all surfaces of the electrode block free of any polishing compound (grit). Since the polishing schedule progresses from coarse to fine, it is very important not to mix large and small particle sizes.
9. Polish the electrode on pads attached to the heavy glass plates provided in the polishing kit. Hold the electrode surface as parallel to the surface of the glass as possible. This is especially important with voltammetry electrodes and will ensure that the surrounding plastic is not worn unevenly.

- Moving the block in a figure-eight pattern is optimal for uniform polishing. However, an alternating clockwise/counterclockwise motion is also acceptable. During all polishing steps, apply even pressure to the electrode block. This may be accomplished by alternating the position on the block to which you are applying pressure:

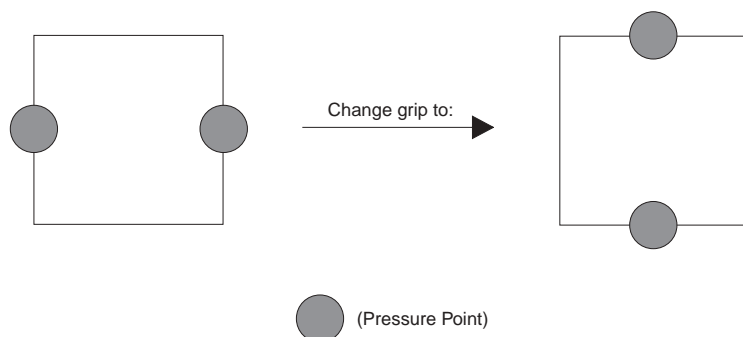

- Never attempt to remove the actual electrode material from the supporting plastic. This will destroy the electrode.
- Do not heat the electrode when drying. Allow it to dry at room temperature. Any heating of the electrode should be attempted with caution due to the difference in the coefficients of expansion of the electrode and the supporting plastic or glass.

3.2 Polishing Glassy Carbon, Silver, or Nickel

Remove a new microcloth disk from the polishing kit. (Microcloth is brown and has a soft, velvety texture.) Peel away the backing to expose the adhesive, and attach the disk to the glass plate. Use a permanent marker to label the glass with the type of polishing fluid used. It is possible to reuse the disks several times, but it is important to use the same type of polish each time. Your label will remind you which polish you used. Now follow these steps (refer to Figure 3.2):

- Rinse the electrode surface with water to flush away any encrusted material on the surface. Follow this with a methanol rinse. Wipe dry with a fresh lab tissue.
- Wet the disk surface with clean DISTILLED water. Shake the alumina suspension and add several drops of alumina polish, spacing them evenly around the pad surface.
- Place the electrode face down on the pad. Using a smooth, circular motion, and even pressure, move the electrode all over the pad. By reversing the polishing direction and rotating the electrode 90° at regular intervals, you will prevent uneven wear of the electrode. After 1–2 minutes, remove the electrode and rinse it well with DISTILLED water.

4. Electrodes may be sonicated to remove residual abrasive particles. Immerse the electrode *surface* in a *shallow* amount of DISTILLED water in a beaker that has been placed in the water of a low-power (150 watts or less) ultrasonic cleaner. Sonicate for no more than 5 minutes (longer periods may overheat and damage the electrode). Rinse again with distilled water from the squeeze bottle and shake off the remaining water.
5. Rinse the electrode briefly with methanol and wipe it dry. The electrode is now ready to use.
6. Do not touch the electrode surface with your fingers, or place the surface in contact with sharp objects or other materials which could scratch it.

Figure 3.2. Polishing steps for glassy carbon, silver, or nickel.

Wet Polishing Pad Before Adding Polish

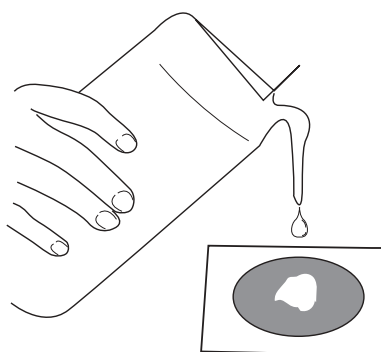

Add a Small Amount of Polish to the Wet Pad

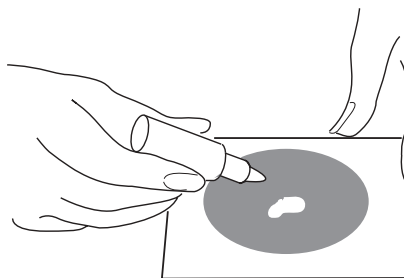

Use Smooth Motion and Even Pressure when Polishing

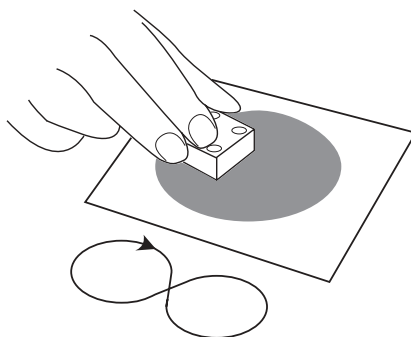

3.3 Electrochemical Cleaning of Platinum

Often, the gradual loss in electrode response is due to slow oxidation of the electrode surface. Sometimes, the redox chemistry depends on the presence of certain catalytic moieties on the surface which must be regenerated. This process can usually be performed electrochemically, without disassembling the cell. For many applications, the need to use an abrasive polish on a platinum electrode is rare.

Alternate the polarity of the working electrode by setting the potential to 500 mV and switching the polarity switch between (+) and (-). Perform at least 10 cycles, pausing at each potential for a few seconds. Return the potential to the desired value and test the response with a standard solution.

If the response does not improve, disassemble the cell and polish the electrode with a methanol-soaked lab tissue. Use firm pressure. Rinse the block with methanol and reassemble. Proceed to the next section only if the response is still too low compared to earlier performance.

3.4 Polishing Platinum and Pure Gold

Remove a new microcloth disk from the polishing kit. (Microcloth is brown and has a soft, velvety texture.) Peel away the adhesive back and attach the disk to the glass plate. Next, remove a nylon disk from the kit. (Nylon disks are white with a tight, woven texture.) Peel away the backing to expose the adhesive, and attach the disk to the OPPOSITE side of the glass plate. There are rubber feet on both sides of the glass so you can use both sides without having to place the polishing surface on your benchtop.

Label each side of the glass with the type of polishing fluid used. Use the brown microcloth with alumina polish, and the white nylon pad with the diamond slurry polish. It is possible to reuse the disks several times, but it is important to use the same type of polish each time. Your label will remind you which polish you used. Shake polishing slurries thoroughly before using. Now follow these steps:

1. Rinse the electrode surface with water followed by methanol to flush away any encrusted material on the surface. Gently wipe dry using a fresh lab tissue.
2. Wet the white nylon disk with DISTILLED water and apply a few drops of the 1- μ m diamond polish slurry (MF-2054).
3. Place the electrode face down on the pad. Using a smooth circular or figure-eight motion and even pressure, move the electrode all over the pad. Reverse direction and rotate the electrode 90° at regular intervals to prevent uneven wear of the electrode. After 1–2 minutes, remove the electrode and rinse away all remaining polishing grit with methanol, using a squeeze bottle.
4. Next, turn over the glass and wet the microcloth disk surface with DISTILLED water. Shake the alumina suspension and add several drops of alumina polish, spacing them evenly around the pad surface.
5. Place the electrode face down on the pad. Polish as in step 3 above. After 1–2 minutes, remove the electrode and rinse well with DISTILLED water.
6. Electrodes may be sonicated to remove residual abrasive particles. Immerse the electrode *surface* in a *shallow* amount of DISTILLED water in a beaker that has been placed in the water of a low-power (150 watts or less) ultrasonic cleaner. Sonicate for no more than 5 minutes (longer periods may overheat and damage the electrode). Rinse again with distilled water from the squeeze bottle and shake off remaining water.
7. Rinse the electrode briefly with methanol and wipe dry. The electrode is now ready to use.
8. Do not touch the electrode surface with your fingers, or place the surface in contact with sharp objects or other materials which could scratch it.

3.5 Polishing Amalgamated Gold

Gold amalgam electrodes consist of a solid gold disk that has been covered with a thin mercury film. When the mercury is gone, the gold must be repolished in several steps. In certain applications where a gold amalgam is used, the mercury is critical to the electrochemical reaction. In determination of thiols, for example, the R-SH complexes with mercury to form a product which is then oxidized. This process will tend to gradually strip away the mercury film. When the electrode performance deteriorates, you can initially try to revive the electrode by reapplying more mercury. A gold tinge is often noticeable on the surface of the working electrode when the electrode loses responsiveness.

To apply more mercury, clean the surface of the electrode with distilled water and wipe it with a methanol-soaked lab tissue. Follow this with more squirts of methanol and then air dry. Add new mercury. This procedure will often buy some extra time before a full repolishing is required. To fully repolish a gold amalgam electrode, follow the instructions in Section 3.5.1.

The final performance of thin-film mercury amalgam electrodes is very dependent on the finish of the gold substrate. A smooth, mirror-like finish produces the best results. A combined acid/abrasive procedure will achieve that goal. The acid treatment quickly removes residual mercury from the electrode surface. The grit pad and diamond polishes do the majority of the polishing, and the alumina polish burnishes the gold back to a shiny appearance in preparation for reapplication of the mercury.

Note for Previous Users of Gold Electrodes:

In early BAS polishing kits, used with Kel-F (white plastic) electrodes, we included a coarse grit polishing pad for use with gold electrodes. This pad had the texture of fine sandpaper and was used for a light initial polishing. In 1990, this pad was discontinued when BAS changed to PEEK plastic (light brown) electrodes. The use of the coarse grit pad caused excessive and deep scratches in both the electrode body and the gold surface, which were not easily removed by subsequent polishing steps. We have now reintroduced a grit pad (MF-1043) for initial polishing of gold PEEK electrodes. Note that this is a different pad than the coarse grit polishing pad previously sold for use with Kel-F electrodes. This dark gray (or black) pad, when thoroughly wetted with water, will produce a uniform surface on gold electrodes that can be further polished to a mirror finish.

3.5.1 Polishing Gold Electrodes in PEEK

Refer to Figure 3.3 when following this procedure.

NOTE: Always remove residual mercury film using 6 N HNO₃ prior to polishing!

1. Rinse the electrode surface with water followed by methanol to flush away any encrusted material on the surface. Shake off the liquid and wipe the surface dry with a lab tissue.
2. Prepare for the next step using the normal precautions required when working with strong acids. Wear rubber gloves, safety glasses, and an apron, and work under a fume hood.
3. Using a pasteur pipette, apply a few small drops of 6 N NITRIC ACID (HNO₃) to the electrode surface. When the color changes from grayish-black to rusty yellow, the old amalgam has been destroyed. Repeat with a second drop of 6 N nitric acid. *Do not use concentrated acid*, which will damage the plastic. After the color turns, rinse thoroughly with water and proceed.
4. Use the fine grit pad (dark gray) wetted with copious amounts of water. Polish for 5 minutes or less, until the gold appears to be of an even matte texture. The mercury has removed some of the gold, so the electrodes are recessed. The PEEK must be removed (polished away) to expose the gold electrodes to the polishing schedule. This is a critical step, so slight overpolishing is preferable to underpolishing. The gold must be exposed to the subsequent polishing and smoothing steps. Flush all surfaces of the electrode with a stream of DISTILLED water to remove grit. Clean electrode with sonication as in step 9. Use the fine grit pad only once and then discard.
5. Apply a few drops of 15- μ m diamond slurry (blue) to a water-moistened nylon pad (white). Polish until gold electrodes and PEEK are each of a uniform texture; this should take 3 to 5 minutes. This intermediate polishing step is important to impart a smooth finish to both the PEEK and the gold. As in step 4, overpolishing is preferable. The diamond slurry is oil-based, so flush the electrode surfaces with a stream of methanol, ensuring that all grit has been removed. Sonicate clean as in step 9. Wipe dry.
6. Apply a few drops of 3- μ m diamond slurry (yellow) to a water-moistened nylon pad (See 3.1, number 3). Polish the electrode for about 2 minutes. Flush and clean the electrode as in step 5. Wipe dry.
7. Apply a few drops of 1- μ m diamond slurry (gray) to a water-moistened nylon pad. Polish, flush, and clean the electrode as in step 6.

8. Apply a few drops of polishing alumina (white) to a water-moistened nylon pad. Polish for about 2 minutes. Flush all electrode surfaces with a stream of water and then methanol.
9. Stand the electrode on one side in a small beaker (100 mL). Add just enough distilled water to cover the plastic block. Clean in a bath sonicator of less than 150 watts power for 2 minutes. Flush the electrode surface thoroughly and sonicate for an additional 2 minutes. Flush the surface again with water and then methanol.
10. The electrode may be wiped dry and stored, or amalgamated for use. Prior to the addition of mercury, the gold surfaces must be rinsed with methanol and wiped dry.
11. To form the amalgam, place a drop of TRIPLE-DISTILLED MERCURY on the gold electrode. Slightly roll the drop around to make sure that it evenly touches the gold in all places. Wait 5 minutes, then use an index card to push off the excess mercury into a waste vessel. Polish the mercury surface with a lab tissue to produce an even layer.
12. Allow the electrode to rest face-up. If the surface becomes dull in 10 minutes or less, you have removed too much mercury, and your amalgam will be short-lived. If the surface remains shiny after 60 minutes, you have not removed enough mercury, and your baseline will be noisy.
13. Allow new amalgam to rest for at least 6 hours, or overnight. The electrode may be installed on a flowing LC system during this rest period, but do not apply a potential (keep the detector on the STANDBY setting). Plan on waiting overnight before using the detector for assays. If you try to use the electrode before this time, you may get a very high background and a change in electrode response over time.
14. When the electrode is not in continuous use, or you plan to store it for an extended period, remove the mercury film using 6 N nitric acid. Polish the electrode again prior to amalgamation.

Figure 3.3. Polishing gold electrodes in PEEK (see Section 3.5.1)

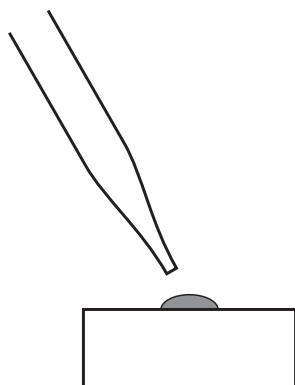

Apply nitric acid with a glass pipette.

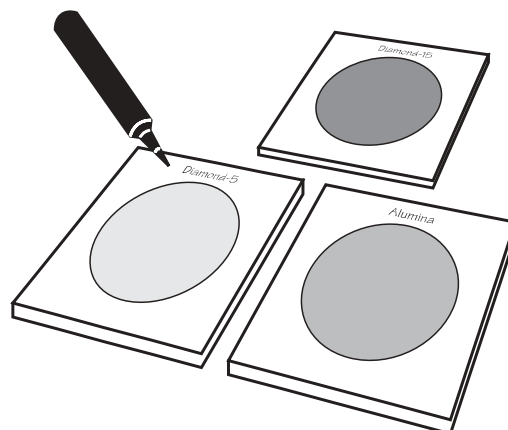

Use fresh polishing pads and label the glass with the type of polishing fluid used.

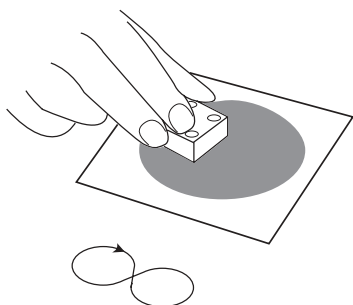

Use a figure-8 motion when rubbing the electrode on the polishing pad.

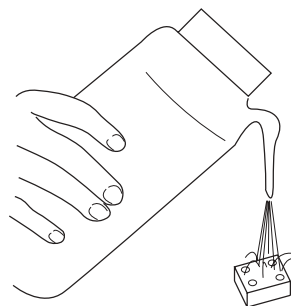

Rinse electrode frequently and extensively with distilled water.

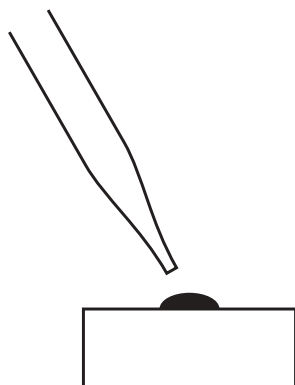

Apply mercury drop to polished surface.

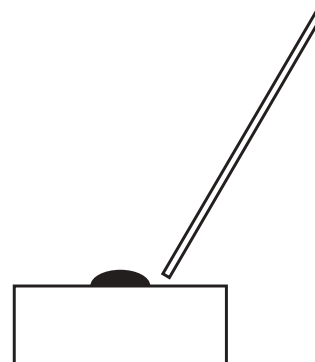

Scrape off excess mercury with a clean index card.

3.6 Preparing Carbon Paste Electrodes

The nice thing about carbon paste is that you don't actually polish it. Instead, you make an entirely new electrode every time. The disadvantage of paste is that it will permanently stain any piece of cloth it encounters. This provides a good excuse for wearing a shirt with a wild pattern that is complementary to abstract, black stains.

Carbon paste offers several interesting possibilities when studying compounds that are soluble in aqueous media. The electron transfer kinetics of carbon paste are markedly different than those of glassy carbon, and some users feel that the electrode offers slightly better sensitivity in some cases. It cannot be used with a high concentration of organic solvents in the mobile phase since this will erode the surface of the paste. Carbon paste compositions vary widely, including combinations of polyethylene or Kel-F powders pressed with carbon. This discussion is limited to handling of pastes currently manufactured by BAS.

Keep the vial of carbon paste closed when it is not in use. Like other forms of graphite, it can absorb contaminants from the laboratory environment. Refer to Figure 3.4 when following these instructions.

1. With a new electrode block (not previously filled with paste), begin by scooping some paste from the vial and dropping it into the open well(s) in the electrode block. In a thin-layer electrode, each well is attached to a gold connector. In a voltammetry electrode, there is an open hole at the end of the electrode rod.
2. Use the end of a glass rod to tamp down the paste evenly into the well eliminating air spaces. Keep filling and tamping it down until the well is filled with carbon paste and is mounded up slightly above the surface of the plastic block. Don't tamp too hard. You should not be squeezing the paste to the point where it begins to ooze oil.
3. Obtain a smooth, CLEAN card. Large index cards work well. Place the card on a flat, hard surface like a large piece of thick, clear glass or a seamless benchtop.
4. Turn the electrode over and draw it gently across the card, leaving a line of carbon on the paper. Then go to a clean section of the card and move the electrode in tiny, continuous circles on the surface of the card. Move to another section and repeat this until little or no paste is left on the paper surface by this action.
5. Turn the electrode over and inspect it. The surface should be even and smooth with no cracks apparent in the surface. Small dark speckles are normal parts of the paste. If any crack or obvious discontinuity is present, return the electrode to a section of the card marked with paste and continue rubbing it in this section to help fill up the cracks and smooth out the surface.

6. If you have been using an electrode and wish to resurface the paste, simply remove about a millimeter of the paste by wiping it away with a lab tissue. Then proceed by dropping a little lump of paste onto a card, pressing the electrode down onto this lump and proceeding as in steps 4 and 5.

Figure 3.4. Polishing carbon paste electrodes. (See Section 3.6.)

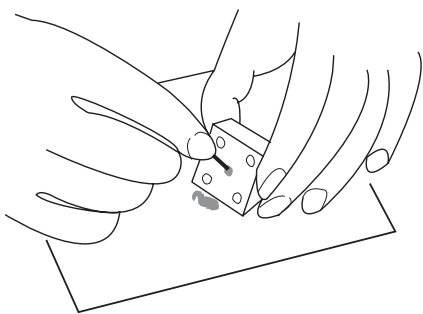

Carefully remove old paste from electrode well.

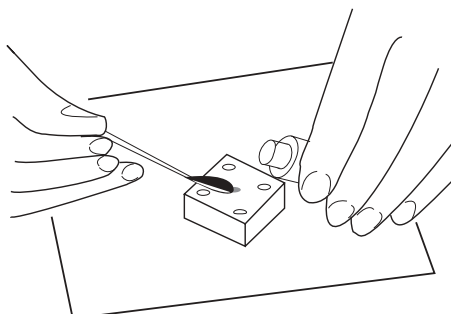

Add a small scoop of new paste to well.

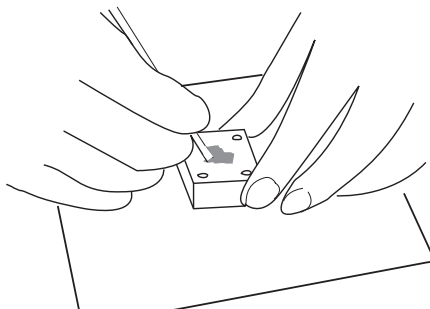

Tamp into well with a small glass rod, leaving a slight mound of paste on electrode.

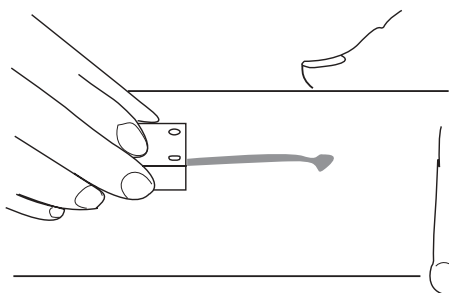

Rub off excess paste on a clean index card.

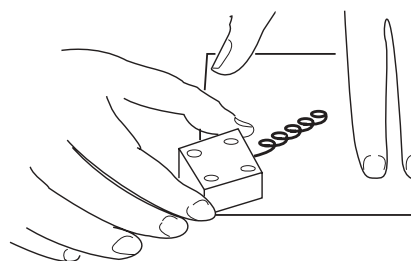

Keep moving to a clean area of card and use circular motion to finish polishing the paste surface.

3.7 Microelectrode Polishing

Microelectrodes are repolished using the same general parameters described previously for glassy carbon, gold, and platinum electrodes. Use smaller overall motions for microelectrodes and keep them as vertical as possible to ensure even polishing. Generally, repolishing of 10- μm to 100- μm diameter electrodes requires much less overall polishing time.

3.8 Polishing the UniJet Electrode

The surface of the UniJet electrode contains both the working electrode and the silver reference electrode (Figure 3.5). You have a choice of polishing one or both of these electrodes.

Figure 3.5. Surface of the UniJet electrode.

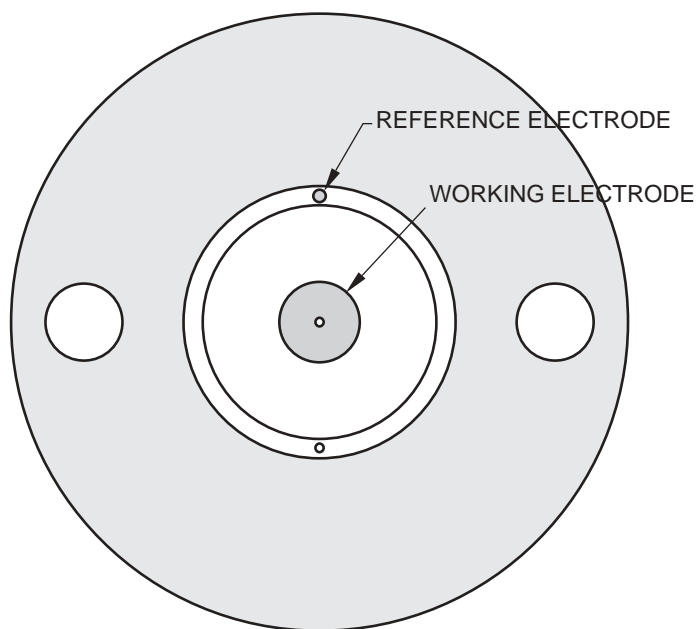

The working electrode needs polishing only if response has declined and you suspect that the electrode is fouled (as discussed at the beginning of Section 3). The reference electrode needs polishing if response has declined and the bronze-colored coating has worn off. After polishing, the reference electrode must be treated to create the AgCl coating (Section 4.3).

To polish both the working electrode and reference electrode simultaneously, simply follow the instructions for whatever material the working electrode is composed of (Sections 3.1–3.6). Invert the electrode assembly onto the polishing pad so that both electrodes are polished.

To polish either the working electrode or the reference electrode independently, apply the appropriate polishing compound with a wooden cotton-tipped applicator. Use a circular motion for even polishing. Rinse with water, then methanol, and allow to air dry.

Section 4. Reference Electrodes

The purpose of the reference electrode is to provide a stable, reproducible voltage to which the working (detector) electrode potential may be referenced. A reference electrode may be considered a small battery whose voltage (potential) is determined by the chemistry taking place between a solid conductor (usually a metal salt) and the electrolytic solution around it. Ideally, if a small current is passed through the electrode, the potential change is negligible, and in any case, returns to the initial value when the current ceases. In addition, the potential value should not vary with time and should be reproducible from electrode to electrode. The most common reference electrodes meeting these criteria are the mercury/mercurous chloride (calomel) and the silver/silver chloride (Ag/AgCl) electrodes.

4.1 Assembling the RE-2 Calomel Reference Electrode

The calomel reference electrode is provided in kit form and is easily constructed. The essential components are the electrode body (an "H" glass design), mercurous chloride (calomel), and KCl. Figure 4.1 depicts an assembled RE-2.

NOTE: Mercury is also used in the RE-2; however, due to recent changes in U.S. Department of Transportation regulations, the mercury cannot be supplied by BAS. Many laboratory suppliers have appropriate licenses and can provide mercury. If you have any questions, please call BAS at 1-800-845-4246.

Figure 4.1. An assembled RE-2 calomel reference electrode.

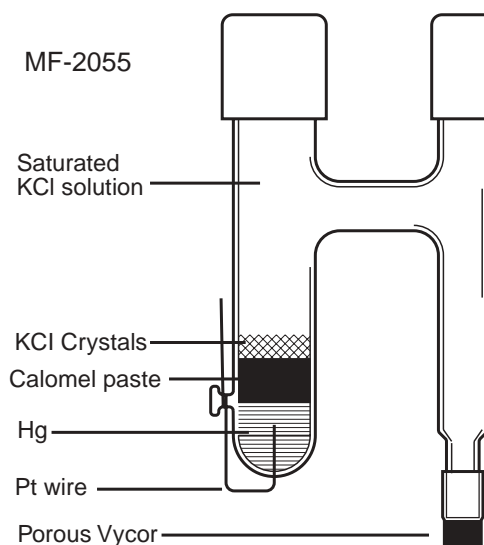

CAUTION: Mercury and calomel are POISONOUS substances. They should be handled carefully, and waste material should be disposed of in accordance with accepted procedures. If the calomel vial has broken in shipping, DO NOT OPEN the protective outer plastic enclosures. Dispose of the vial and contents as a single unit. Call BAS (1-800-845-4246) for a replacement.

Kit Components

1. Glass electrode "H" body with a porous Vycor[®] junction, platinum wire, and two yellow caps
2. Calomel paste (labeled Vial B)
3. Saturated KCl solution (labeled Vial C)

Tools and Materials Required But Not Provided

1. Disposable pasteur pipettes
2. 1-mL pipette with bulb
3. Small beaker, or a small flask fitted with a one-hole rubber stopper that can accommodate the narrower arm of the glass body (fill the flask or beaker with saturated KCl solution, and clamp it to a ring stand for support)
4. Plastic tray to collect spills
5. Rubber gloves
6. Triple distilled mercury

Assembling the Calomel Reference Electrode

1. Place the electrode body upright, using the small flask of KCl solution for support. The narrow arm with the Vycor tip should fit comfortably into the hole in the stopper and the Vycor should be wetted by the solution.
2. Hold the reference electrode body and remove both yellow caps.
3. Carefully pour the mercury into the wide arm (the one with the platinum wire on it) and make sure none of the mercury crosses the bridge into the other arm.
4. Use the 1-mL pipette to dispense 0.5 mL of saturated KCl (Vial C) into the calomel paste (Vial B). Use the tip of a pasteur pipette to mix paste and solution into slurry.
5. Using the same pipette, transfer small aliquots of the slurry to the wide arm of the body and gently layer it on top of the mercury pool. Be careful not to allow any of this material to touch the connecting bridge or reach the other arm of the body.
6. Allow slurry to settle. Draw off excess KCl solution with the pasteur pipette and discard.
7. Repeat steps 5 and 6 until the calomel layer is 5 mm deep.

8. Using a new pipette, gently fill the other arm of the electrode with saturated KCl solution. Keep filling until the solution is within 5 mm of the top of the electrode and the connecting bridge is filled.
9. Replace the yellow caps and store the electrode in the stoppered flask of saturated KCl.
10. After at least 2 hours, the Vycor tip will be fully wetted and the RE-2 will be ready for use. A small bubble will have formed above the Vycor plug inside the electrode. Gently tap the electrode with your finger to dislodge the bubble prior to use.

RE-2 Usage

The RE-2 calomel reference electrode is relatively fragile. Avoid any jarring or other activity which would disrupt the mercury/calomel/saturated KCl solution interfaces. Disturbing these layers would necessitate rebuilding the electrode.

The Vycor tip, once wetted, must always be kept wet. When not in use, keep it immersed in saturated KCl solution.

The solution level in the electrode must always be kept above the connecting bridge. Remove the yellow caps periodically and add more KCl to the Vycor arm side of the electrode as needed.

If bubbles form, dislodge them by tapping the electrode with your finger to maintain contact of the Vycor with the solution.

4.2 Silver/Silver Chloride (Ag/AgCl) Reference Electrodes

BAS offers several models of Ag/AgCl reference electrodes (Figure 4.2). Each reference electrode is individually inspected and tested for adherence to an acceptable range relative to a standard calomel electrode.

Figure 4.2.

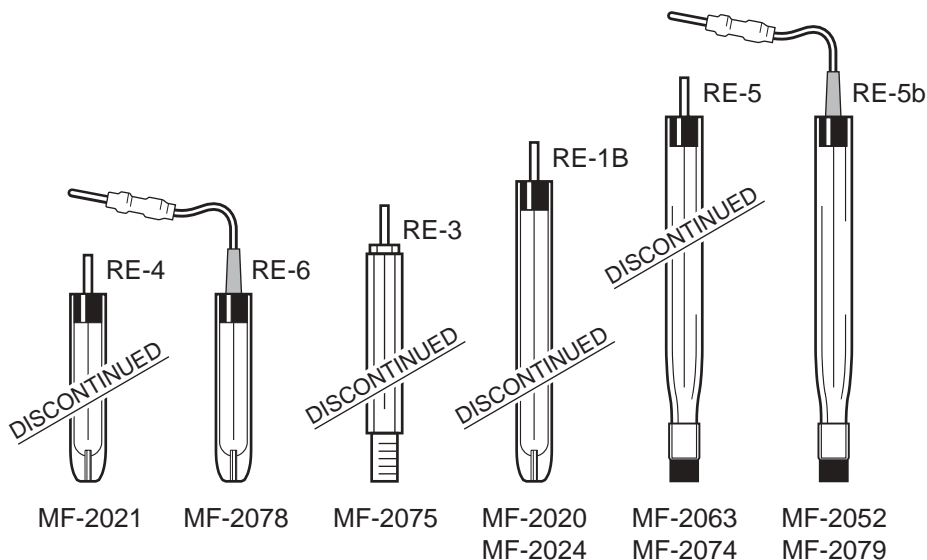

The model **RE-6** (MF-2078) is the shortest (3 cm), and fits into the thin-layer flowcell used in current model LCEC detectors. It features glass-body construction with a porous ceramic frit at the solution interface. The filling solution is 3 M NaCl gel that has been saturated with AgCl; the gel is semi-solid and will appear cloudy with occasional particles.

The model **RE-5b** (MF-2052 or MF-2079) has the same diameter as the RE-6, but uses a porous Vycor frit at the solution interface. The filling solution is aqueous 3 M NaCl that has been saturated with AgCl.

Use of a reference electrode with bubbles lodged in the tip may prevent electrical contact with the sample solution and cause damage to the working electrode. Bubbles can be dislodged by holding the top of the electrode with one hand and tapping the electrode near the Vycor tip with the other hand until the bubbles rise to the top.

Removing the Sheath

Every Ag/AgCl reference electrode is shipped with a colored plastic sheath that covers the porous tip and retards drying. IMMEDIATELY UPON RECEIPT, REMOVE THIS SHEATH BY ROLLING IT DOWN FROM THE GLASS BODY TO THE TIP (see Figure 4.3). The plastic will roll down and slide off the end of the electrode. Do not tug at the sheath or hold the electrode by the pin while you are doing this. If you have trouble removing the sheath, make a small cut at the upper edge of the sheath using small scissors, and try again.

CAUTION: Be extremely careful when removing the plastic sheath from the RE-5b reference electrode. The Vycor frit is attached to the glass body with heat-shrink Teflon, which can be pulled off. The best method is to cut the length of the plastic sheath with scissors. A scalpel may be used, but there is greater chance of damaging the heat-shrink tubing.

ONCE THE SHEATH IS REMOVED, STORE THE ELECTRODE TIP IN 3 M NaCl AS SHOWN IN FIGURE 4.4. The Ag/AgCl reference electrodes are easily ruined by drying. Keep the tips wetted at all times and store in 3 M NaCl when not in use. A reference electrode storage vial is available from BAS (MR-5275).

Figure 4.3. Removing the RE-6 reference electrode's colored plastic sheath.

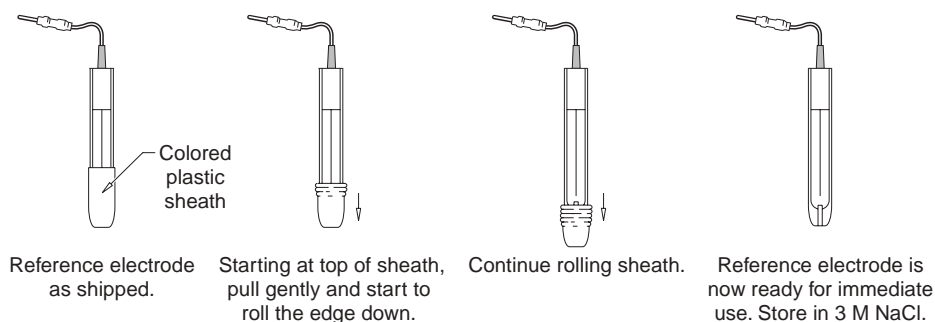

Storing Ag/AgCl Reference Electrodes

Be sure that you check the electrodes periodically and replace the solution in the storage vessel with fresh 3 M NaCl to keep the tips wet. **DO NOT ENTIRELY IMMERSE REFERENCE ELECTRODES.** Keep the connecting pins dry, or they will corrode and contaminate the reference electrode.

Figure 4.4. Storing silver/silver chloride reference electrodes.

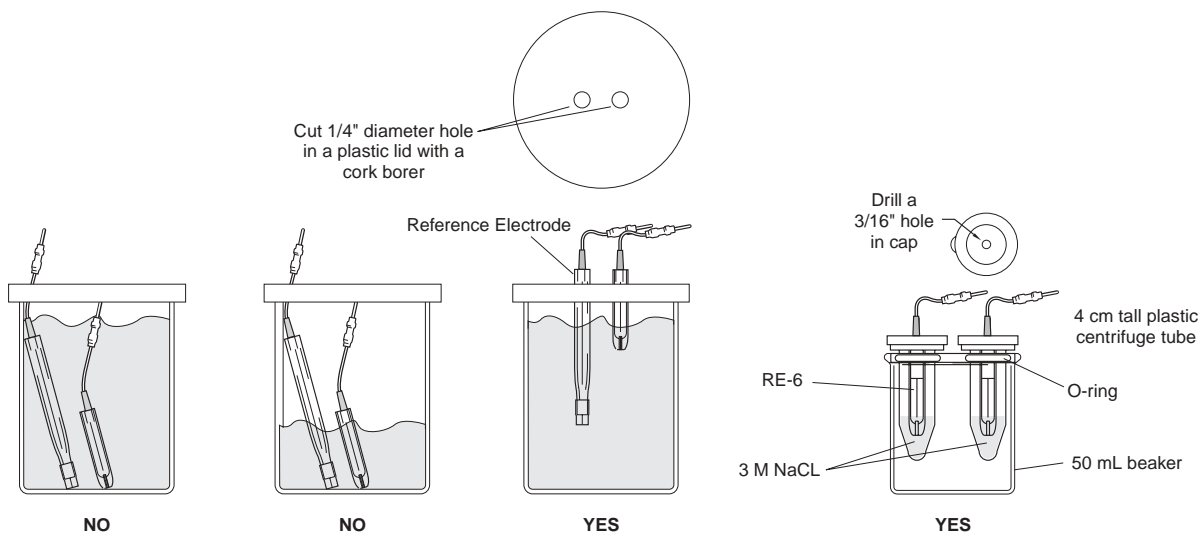

Reference electrodes will naturally change with use due to the transport of ions and solvent across the junction (ceramic or Vycor tip). The rate of change is a function of the difference in composition between the sample solution (i.e., mobile phase in liquid chromatography) and the filling solution (3 M NaCl gel). In LCEC usage, it is advisable to change to a new reference electrode frequently, at least once per month. [See *Current Separations* Vol. 11 No. 1/2 for more about the role of a reference electrode.] Storing the reference electrode in 3 M NaCl between experiments will extend its lifetime. In spite of all attempts to extend their lifetimes, reference electrodes are still expendable items, so be certain to have spares on hand as needed.

Testing the Viability of Ag/AgCl Reference Electrodes

If you are concerned about the viability of a particular Ag/AgCl reference electrode, you can test it using a simple voltmeter, additional reference electrodes of the same type (or a calomel reference electrode), and a small beaker of 3 M NaCl (see Figure 4.5). Read the potential difference between the electrodes on the voltmeter. Ideally the difference between two electrodes of the same type would be zero. However, in actual practice there is commonly some variation.

If the two electrodes are of the same type (e.g., Ag/AgCl vs. Ag/AgCl, or calomel vs. calomel) the meter should read 0 ± 20 mV. If your reading for any pair of electrodes is significantly different, you should have another electrode of the same type handy to help distinguish which of the two is bad. When comparing an Ag/AgCl reference electrode to a calomel electrode, make the calomel the black (negative) input on the voltmeter. The meter should then read -35 ± 20 mV. A single-probe combination pH electrode is not suitable for this test.

Figure 4.5. Testing the viability of Ag/AgCl reference electrodes.

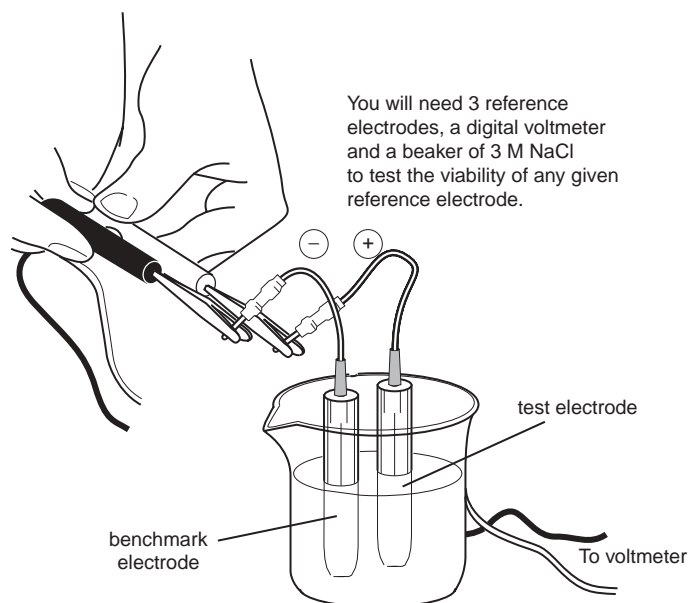

Rotation of Ag/AgCl Reference Electrodes

We recommend that three reference electrodes be rotated in your LCEC system. Keep one electrode in your system for about two weeks. Turn the detector to STANDBY before removing and replacing the electrode. (Failure to do so can ruin a glassy carbon working electrode.) Rinse excess 3 M NaCl storage solution off the replacement reference electrode before inserting it into the cell. Replace the bushing and O-ring if they show signs of wear. Turn the cell on. Place the first electrode into the storage container. In another two weeks, replace the reference electrode with the third reference electrode provided in the kit. By rotating the three reference electrodes provided with your detector on a continuous basis, you can maximize their lifetimes. Depending on the mobile phase conditions and detector use, the reference electrodes can last from 6–12 months. When you replace reference electrodes, replace all three of them at the same time.

4.3 UniJet Reference Electrodes

The UniJet detector is shipped with a silver wire coated with AgCl (the Ag/AgCl reference electrode). It should be regenerated each time the mobile phase is changed or the electrode is polished (Section 3.8). After polishing and rinsing with water and methanol, apply a drop of the reference electrode coating solution (CF-2200) to the electrode surface (see Figure 4.6). Do not allow the solution to get on the working electrode or on your skin. Leave the solution on the electrode for 5 minutes. Rinse the electrode with water. The reference electrode should be a dull bronze color and uniform in appearance.

The UniJet reference electrode is a pseudo-Ag/AgCl reference electrode. The reference electrode potential is determined by the quantity of Cl^- in the mobile phase. The higher the Cl^- concentration, the closer the reference will become to a standard Ag/AgCl. We recommend using 10 mM NaCl in any mobile phase to increase the stability of the reference electrode and prevent alterations in the potential. The UniJet reference electrode is about 100 mV more positive than the standard RE-4 Ag/AgCl reference electrode. Thus, the potential set on the detector should be 100 mV less than was used with an RE-4.

Figure 4.6. Coating the UniJet reference electrode.

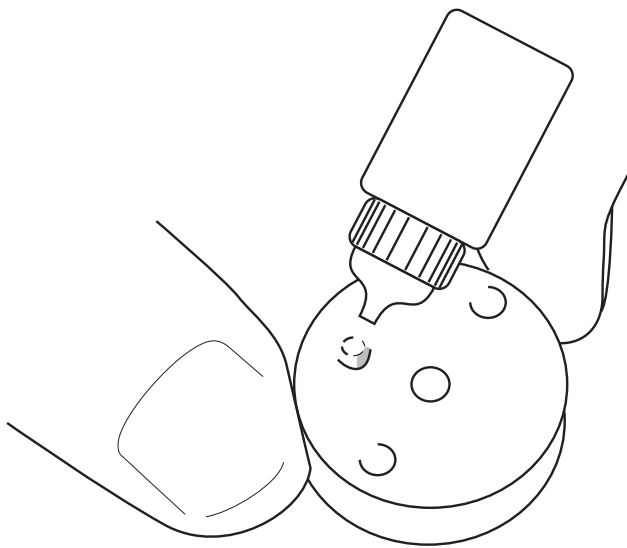

4.4 Silver/Silver Ion (Nonaqueous) Reference Electrodes

The Ag/Ag^+ reference electrode is commonly employed in nonaqueous electrochemical studies. Aqueous reference electrodes (e.g., calomel and Ag/AgCl) have several drawbacks. These include liquid junction potentials, contamination of solvent solution by water, and precipitates at the reference electrode frit that cause noise and even failure of the reference electrode.

The Ag/Ag^+ reference electrode is made by placing a clean silver wire into an electrolyte containing silver ion. Often the electrolyte in the reference compartment is the same as the solution electrolyte. Typical salts are tetrabutylammonium perchlorate (TBAP), tetraethylammonium perchlorate (TEAP), tetrabutylammonium hexafluorophosphate, and tetrabutylammonium tetrafluoroborate at approximately 0.1 M concentration. Typical polar and dipolar aprotic solvents are acetonitrile (ACN), dimethylformamide (DMF), dimethylsulfoxide (DMSO), and propylene carbonate (PC). In cases where a salt is not sufficiently soluble in the solvent being used (e.g., methylene chloride, tetrahydrofuran, etc.), the recommended reference electrode filling solution uses a more polar, yet miscible solvent like acetonitrile.

Silver ion is formed by dissolving 0.001 to 0.01 M AgNO_3 , AgClO_4 , or other silver salt in the chosen electrolyte. The silver ion electrolyte is usually changed daily although the frequency depends on the experiments performed.

For additional information, see D.T. Sawyer, A. Sobkowiak, and J.L. Roberts, Jr., "Electrochemistry for Chemists," 2nd Ed., Wiley Interscience, New York, 1995, pp 201-203.

Assembly of the Nonaqueous Reference Electrode

1. Fill the glass body with electrolyte (e.g., 0.1 M TBAP/CH₃CN).
2. Place the glass body/Vycor assembly into electrolyte. This will wet the Vycor after an hour or so. Note that gas bubbles will form on top of the Vycor as it wets. Remove these by tapping the glass body with your finger. Cover the whole container to prevent or slow evaporation of the solvent.
3. A clean silver surface is obtained by a light polish with 600 grit sandpaper. Then rinse the wire with distilled water, followed by acetone. Allow the wire to dry before use.
4. When the Vycor is wetted, remove the solvent electrolyte from the glass body assembly. Add a known concentration of silver ion solution (e.g., 0.01 M AgNO₃, 0.1 M TBAP/CH₃CN) to 1/2" from the top of the tube. Place the cap and the silver wire assembly into the glass body assembly. Remove air bubbles in the narrow part of the glass by tapping the electrode body. The reference electrode is ready to use.

For storage, the internal silver ion electrolyte solution should be removed and replaced with electrolyte alone. Then place this assembly in a container of electrolyte and cover it. Doing this keeps the Vycor frit material wet and also cleans it of foreign material, such as precipitates that may have been deposited during use.

CAUTION: Do not allow the Vycor tip to become completely dry. The salt crystallizing inside the Vycor will cause it to break and leak.

4.5 Replacing the Vycor Tip

Shrink a 1/2" length of heat-shrink Teflon tubing onto the glass body tip and over a 1/8" length Vycor plug. Trim off the excess Teflon tubing.

Section 5. Part Numbers

Please consult the current BAS pricebook for pricing of these parts.

5.1 Polishing Kit and Supplies

MF-2060	PK-4 Polishing Kit
CF-1050	Polishing Alumina, 0.05 μm , 7 mL
MF-2051	Coarse Polishing Diamond, 15 μm , 2 mL
MF-2053	Medium Diamond Polish, 6 μm , 2 mL
MF-2059	Fine Diamond Polish, 3 μm , 2 mL
MF-2054	Very Fine Diamond Polish, 1 μm , 2 mL
MF-1043	Fine Grit Pads, 20/pkg
MF-1040	Alumina Polish Pads, 20/pkg
MF-2058	Nylon Diamond Polish Pads, 20/pkg

5.2 Thin-Layer Cell Parts For Current Model LC-44 Detector**Reference Electrodes**

MF-2078	RE-6 Ag/AgCl Reference Electrodes, 3/pkg
MF-2022	RE-4 Replacement Bushing, 10/pkg
MF-2023	RE-4 Replacement O-Ring, 10/pkg
MR-1245	One (1) Replacement O-Ring for Organic Solvent Accessory

Cross-Flow Working Electrodes

MF-1000	One (1) Dual Glassy Carbon Electrode
MF-1024	Ten (10) Dual Glassy Carbon Working Electrodes
MF-1002	Dual Gold Working Electrode
MF-1004	Dual Carbon Paste Working Electrode
CF-1010	Carbon Paste, Oil-Based, 1 g
MF-1006	Dual Glassy Carbon/Gold Working Electrode
MF-1008	Dual Silver Working Electrode
MF-1009	Dual Nickel Working Electrode
MF-1012	Dual Platinum Working Electrode
MF-1013	Dual Platinum/Glassy Carbon Working Electrode
MF-1044	Special Microbore Gasket, 0.0005" thick, 3/pkg
MF-1046	Opaque Teflon Gasket, 0.002" thick, 4/pkg
MF-1047	Opaque Teflon Gasket, 0.005" thick, 4/pkg
MF-1048	Opaque Teflon Gasket, 0.015" thick, 1/pkg
	Custom electrodes available.

Radial Flow Working Electrodes

MF-1003	UniJet Glassy Carbon Working Electrode (3 mm) (reference included)
MF-1007	UniJet Gold Working Electrode (3 mm)
MF-1014	UniJet Platinum Working Electrode (3 mm)
MF-1016	UniJet Glassy Carbon Working Electrode (6 mm)
MF-1017	UniJet Glassy Carbon Working Electrode (2 mm)
MF-1055	UniJet Gaskets (16- μ m), 3/pkg
MF-1997	CC-5 Auxiliary Electrode UniJet Lead
MF-1996	Rheodyne 7125 Injection Valve Isolation Kit (for CC-4/CC-5 cabinets)
MW-1057	UniJet Auxiliary Electrode
MR-3349	4-40 \times 1/2" screw (2 required)
MR-3061	Hex Driver
MR-3916	UniStand™
CF-2200	UniJet Reference Solution (10 mL)

5.3 Thin-Layer Cell Parts for Older Cell Designs

Reference Electrodes

MF-1026	RC-2A Reference Electrode Compartment, Kel-F
MF-1027	O-Rings for Reference Compartment, 10/pkg
MF-2079	RE-5b Reference Electrodes, 3/pkg
MF-2019	Organic Solvent Accessory: High-pressure reference electrode retainer and sealing O-ring for high concentrations of organic solvent in mobile phase

Working Electrodes

NOTE: None of these electrodes provides an additional outlet port for fraction collection. This option is no longer available.

MF-1000	One (1) Dual Glassy Carbon Electrode
MF-1024	Ten (10) Dual Glassy Carbon Working Electrodes
MF-1002	Dual Gold Working Electrode
MF-1004	Dual Carbon Paste Working Electrode
CF-1010	Carbon Paste, Oil-Based, 1 g
MF-1006	Dual Glassy Carbon/Gold Working Electrode
MF-1008	Dual Silver Working Electrode
MF-1009	Dual Nickel Working Electrode
MF-1012	Dual Platinum Working Electrode
MF-1013	Dual Platinum/Glassy Carbon Working Electrode

Other Parts for Older Cell Designs

MF-1018	Stainless Steel Auxiliary Electrode Block
MF-1049	Twelve (12) Cell Screws and One (1) Wrench
MF-1030	5 mL Flushing Syringe with Threaded Fitting
MF-1039	Teflon Inlet Tube with 2 Fittings, 1/16" o.d., 2/pkg
MF-1034	Teflon Outlet Tube with 2 Fittings, 1/8" o.d., 2/pkg
MF-1046	Opaque Teflon Gasket, 0.002" thick, 4/pkg
MF-1047	Opaque Teflon Gasket, 0.005" thick, 4/pkg
MF-1048	Opaque Teflon Gasket, 0.015" thick, 1/pkg

5.4 Voltammetry Electrodes

Reference Electrodes

MF-2062	Nonaqueous Reference Electrode Kit
MF-2055	RE-2 Calomel Reference Electrode Kit
MF-2052	RE-5b Ag/AgCl Reference Electrode with Vycor Tip
MF-2079	RE-5b Reference Electrodes, 3/pkg

Working Electrodes

MF-2010	CPE Carbon Paste Voltammetry Electrode
MF-2011	AGE Silver Voltammetry Electrode
MF-2012	GCE Glassy Carbon Voltammetry Electrode
MF-2013	PTE Platinum Voltammetry Electrode
MF-2014	AUE Gold Voltammetry Electrode
MF-2015	MCPE Carbon Paste Electrode for Microcell Assembly
MF-2016	NIE Nickel Voltammetry Electrode
MF-2018	PDE Palladium Voltammetry Electrode
CF-1010	CPO Carbon Paste, 1 g
MF-2005	Platinum Microelectrode (10 μm)
MF-2006	Gold Microelectrode (10 μm)
MF-2007	Carbon Microelectrode (11 μm)
MF-2150	Platinum Microelectrode (100 μm)
MF-2066	Glassy Carbon Electrode for Rotating Disk Electrode
MF-2067	Platinum Electrode for Rotating Disk Electrode
MF-2068	Gold Electrode for Rotating Disk Electrode

Custom electrodes available.

Auxiliary Electrodes

MW-1032	Platinum Wire Auxiliary Electrode (5 cm) in CTFE Cylinder (C3 and Low Current Module)
MW-4130	Platinum Wire Auxiliary Electrode (5 cm) for C-1A and C-1B Cell
MW-1033	Coiled Platinum Wire Electrode (23 cm) for Rotating Disk Electrode

Index**A**

Abrasives

see Alumina polish, Diamond slurries

Ag/Ag ⁺ reference electrodes	29, 30
replacing the Vycor tip	30
Ag/AgCl reference electrodes	2, 6, 24, 28
removing the sheath	25
rotating	27
storing	25, 26
testing the viability of	26
Alumina polish	10, 13, 15
Auxiliary electrodes	
for thin-layer cells	2
for voltammetry cells	6

C

Calomel reference electrodes

see RE-2 reference electrodes

Carbon paste working electrodes	1, 5, 6
polishing	19
preparing	18
resurfacing the paste	19
Cell preheater	2
Chemically modified electrodes	8
Cross-flow cell design	2

D

Designs of thin-layer cells

cross flow	2
radial flow	4
Diamond slurries	8, 9
1- μm	13, 15
15- μm	15
3- μm	15

E

Electrochemical cleaning of platinum	12
Electrode polishing	7
amalgamated gold	14
carbon paste	19
general guidelines	9
glassy carbon	10
gold	15, 17
gold amalgam	14
microelectrodes	20
nickel	10
pads	9
platinum	12
pure gold	12
silver	10
UniJet	20

G

Glassy carbon working electrodes	1, 5
polishing	10
Gold amalgam electrodes	
applying more mercury	14
polishing	14
Gold working electrodes	1, 5
polishing	15, 17

M

Mercurous chloride reference electrodes	
<i>see</i> RE-2 reference electrodes	
Mercury, triple-distilled	16, 21, 22
MF-2020	
<i>see</i> RE-1B reference electrodes	
MF-2021	
<i>see</i> RE-4 reference electrodes	
MF-2024	
<i>see</i> RE-1B reference electrodes	
MF-2063	
<i>see</i> RE-5 reference electrodes	
MF-2074	
<i>see</i> RE-5 reference electrodes	
MF-2075	
<i>see</i> RE-3 reference electrodes	

Microbore chromatography	4
Microcloth	10, 12
Microelectrodes	6
polishing	20

N

Nickel working electrodes	1, 5
polishing	10
Nonaqueous reference electrodes	29, 30

P

Platinum working electrodes	1, 5
electrochemical cleaning	12
polishing	12
Polishing	
general	9
glassy carbon	10
gold	12
gold amalgam	14
microelectrodes	20
nickel	10
pads	9
platinum	12
silver	10
UniJet	20

R

Radial-flow cell design	4
RDE-1 rotating disk electrodes	6
RE-1B reference electrodes	1, 24
RE-2 reference electrodes	6
assembling	21, 22
usage	23
RE-3 reference electrodes	1, 24
RE-4 reference electrodes	1, 24, 28
RE-5 reference electrodes	1, 6, 24
Reference electrodes	
Ag/Ag+	29, 30
Ag/AgCl	2, 6, 24, 28
coating solution	28
for thin-layer cells	1
for voltammetry cells	6
general	21

RE-1B.....	1, 24
RE-2.....	6, 21, 22, 23
RE-3.....	1, 24
RE-4.....	1, 24, 28
RE-5.....	1, 6, 24
unpacking and storage.....	25
Rotating disk electrodes.....	5, 6
Rotation of Ag/AgCl reference electrodes.....	27

S

SepStik microbore column.....	4
Sheath.....	25
Silver working electrodes.....	1, 5
polishing.....	10
Silver/silver chloride reference electrodes	
<i>see</i> Ag/AgCl reference electrodes	
Silver/silver ion reference electrodes	
<i>see</i> Ag/Ag ⁺ reference electrodes	
Slurries	
<i>see</i> Diamond slurries	
Sonication.....	11, 13, 16
Storage vial.....	25
Storing Ag/AgCl reference electrodes.....	25, 26

T

Temperature control.....	2
Testing viability of reference electrodes.....	26
Thin-layer cells	
auxiliary electrodes.....	2
general.....	1
reference electrodes.....	1
working electrodes.....	1
Triple-distilled mercury.....	16, 21, 22

U

Ultrasonic cleaning	11, 13, 16
UniJet detector	4
UniJet electrodes	
design	4
polishing	20
reference electrode	28

V

Voltammetric microelectrodes	5
Voltammetry cells	
auxiliary electrodes	6
general	5
reference electrodes	6
working electrodes	5
Voltammetry electrodes	5
Vycor tip	30

W

Working electrodes	
carbon paste	1, 5, 6, 18
for thin-layer cells	1
for voltammetry cells	5
glassy carbon	1, 5
gold	1, 5
gold amalgam	1
nickel	1, 5
platinum	1, 5
silver	1, 5

